

PERFIL L 35x35X3

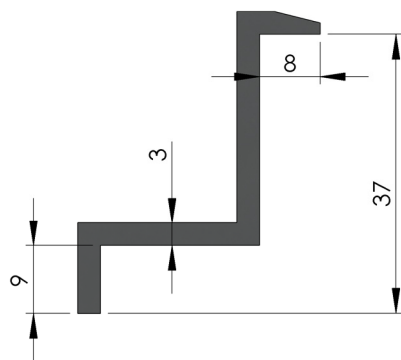

END CLAMP 35/40 KIT

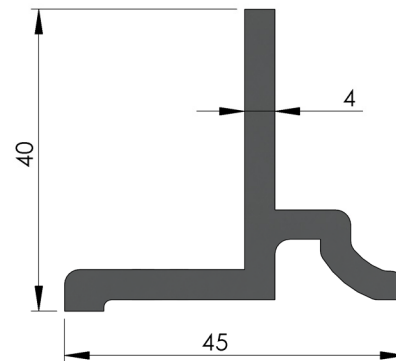

CLAMP KIT

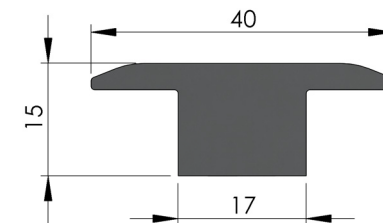

INTER CLAMP 35/40 KIT

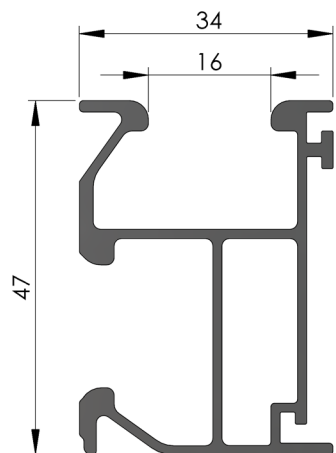

GUÍA PRO STANDARD

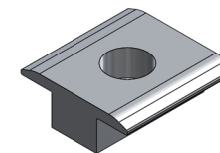
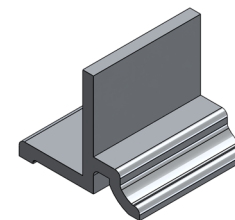
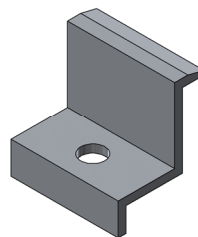

ESCALA 1:2

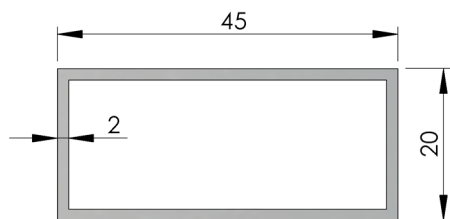

PERFIL 45x20

ESTRUCTURA TRIANGULAR			
REV	FECHA	DESCRIPCIÓN	DISEÑADO
1	23/02/2021	Componentes	DC
2			
CLIENTE			
UBICACIÓN			
COORDENADAS			
ESCALA 1:1	PERFILES / SUJECIONES		Nº PLANO 3