

# Armario U16

## Para baterías Pylontech



### Key Features

#### Top Cover with Fans (Optional)

- 120mm\*120mm fans can be preinstalled on the top cover

#### Removable Side Panel

- Removable side panel simplifies your installation of accessories and monitoring of IT Equipment

#### Reinforcing Triangle Metal in the Corner

- Reinforcing triangle metal in each corner to make the structure of the rack more solid

#### Easy Cable Entry

- Cable entry on both of top cover and bottom panel

### Components

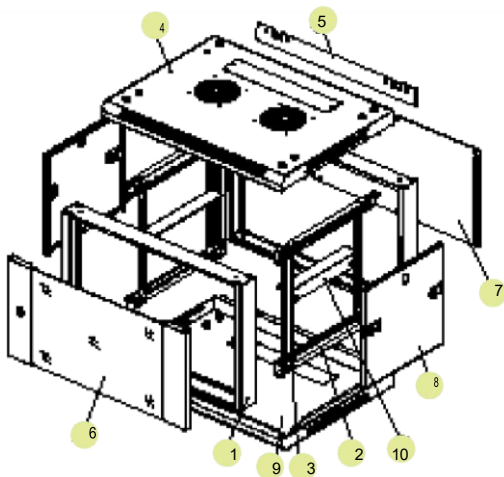

S/N	Name	Quantity
1	Frame	2
2	Horizontal bracket	4
3	Vertical rail	4
4	Top cover	1
5	Bottom panel	1
6	Front door	1
7	Rear panel	1
8	Side panel	2
9	Mounting bracket	1
10	L-shaped bracket	2

# Armario U16

## Para baterías Pylontech

### Main Dimension

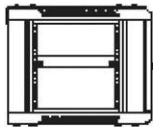

Left View

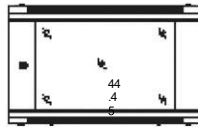

Front View

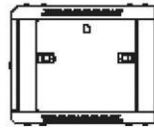

Right View

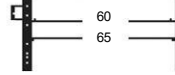

Mounting Dimension

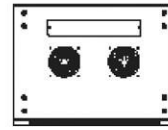

Top View

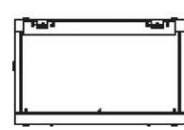

Rear View

### Optional Doors

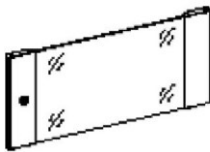

Door: Tempered glass  
Lock: Small Round

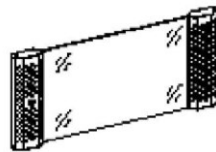

Door: Tempered glass with vented holes  
Lock: Small Round

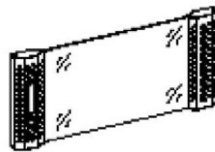

Door: Tempered glass with vented holes  
Lock: Spring

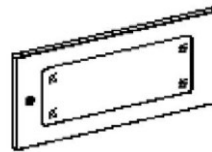

Door: Tempered glass  
Lock: Small Round

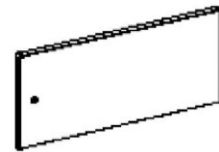

Door: Solid Iron  
Lock: Small Round

### Part Number Builder

Part Number Example		Description						
<b>WB-SS66080NB</b>		SS Series, 600mm Width, 600mm Depth, 08U Capacity Wall Mount Cabinet						
<b>W</b>	<b>B</b>	<b>S</b>	<b>S</b>	<b>6</b>	<b>6</b>	<b>08</b>	<b>0N</b>	<b>B</b>
WebIT		Product Code		600mm (W)	600mm (D)	08U Capacity	Door Style	Color

### Specification

Part Number	Capacity (U)	Width	Depth	Height
<b>WB-SS66080NB</b>	8	600 mm	600 mm	457 mm
<b>WB-SS66120NB</b>	12	600 mm	600 mm	635 mm
<b>WB-SS66160NB</b>	16	600 mm	600 mm	813 mm

**Note:** Hardware: ≤12U:12 sets cage nuts, >12U:24 sets cage nuts, B for Black, G for Grey

### Optional Accessories

- Fixed Shelf
- Sliding Shelf
- Cable Management
- Cooling Solution
- Air Flow Management
- PDU